

O&M Manual  
*Revision 4.1*

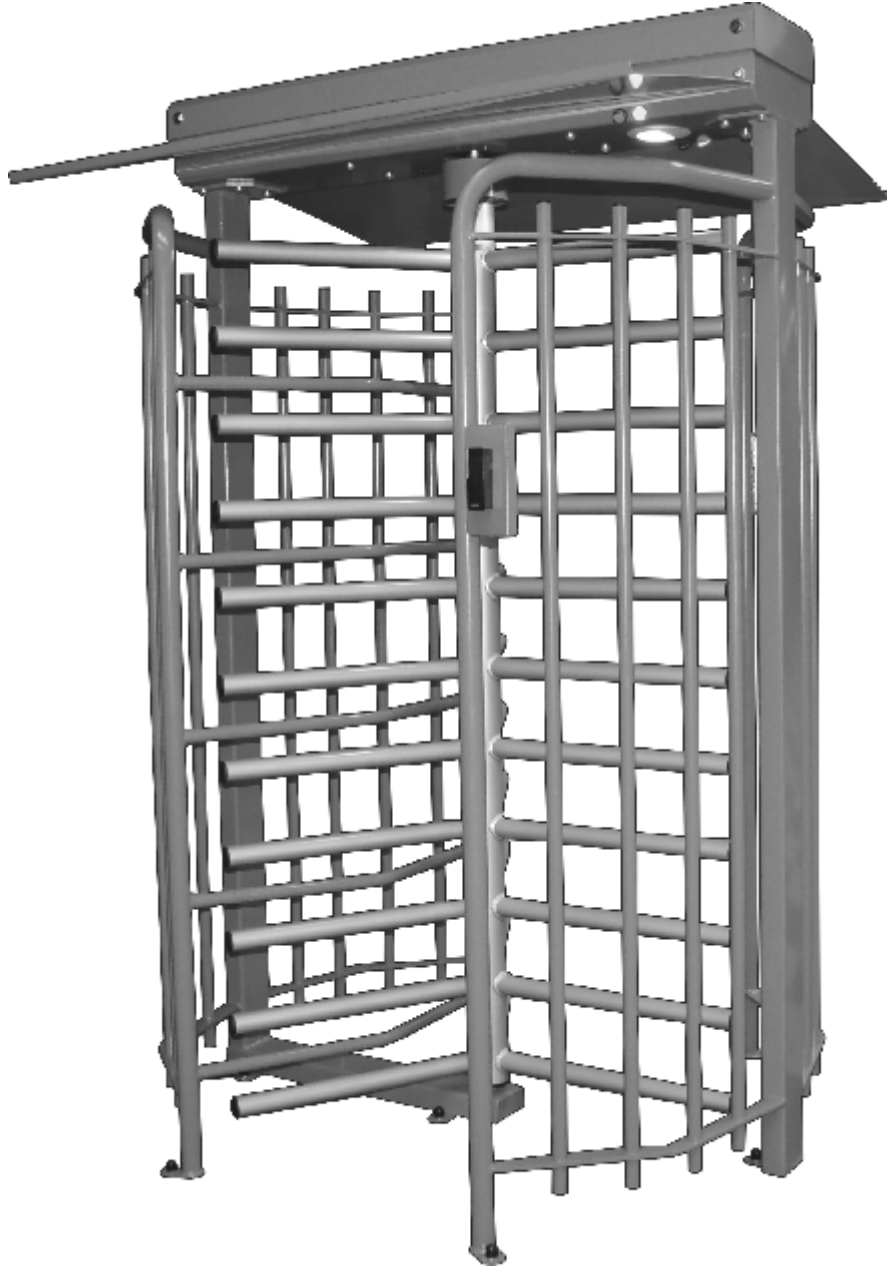

## **PF4000FH**

Automatic Full height Turnstile

Single or Double .....  
Duty Cycle: 100% .....



This equipment is part of a large range of traffic flow products. They are designed to be easy to install, as all settings and internal wiring have been completed in our factory. Any of the instructions in this manual should only be carried out by a qualified service engineer or a competent person.

The turnstiles are ready to bolt down, connect to a single phase power supply and have any access control wired into them (Please note that advice should be sought on wiring instructions). The steps must be completed before the power is turned on to prevent accidents.

The following information is a guide only, and whilst we have made every effort to be accurate and correct there may be errors which we cannot be held responsible for.

With a correct installation you can expect to enjoy many years of reliable service from this product, we do however recommend that the product has a bi-annual service carried out by a qualified engineer. Please contact our service department to obtain a quote. As we manufacture the products we are best suited to care for your equipment.

Thank you for your custom and welcome to the exciting world of Total Traffic Flow Solutions.

## Important Safety Notice



Automatic turnstiles are designed to Control the flow of human traffic only. It can be dangerous to allow the passage of any other self-powered animal or device to utilise this method of access without appropriate warnings and or signage. It may be necessary for the end user of this product to provide an alternative, safe method of access to cater for the previously mentioned categories.

The end user should fit all necessary signage and warning notices to either side of the turnstile, which should be visible and clear from all directions of approach.

The product that was shipped to you was designed with a control program to protect all categories from harm or affect this however is only a precaution. It should not be modified or tampered with by any unauthorised person not sanctioned by the manufacturer.

Please sign and date below to say that you have read and understood this notice before ANY installation work:

/ /20

## Information on using this manual



- Read all information thoroughly
- Pay attention to all safety advice
- Be aware of the symbols (shown above right and above left) as they have different meanings. One is an information symbol, the other a warning.
- There are many artists impressions of the product in this manual you should refer to the images as a guide only. **Professional CAD** drawings should be used as a reference drawing and nothing else. As before every effort has been made to be 100% accurate in this manual but we cannot make any guarantees.
- As we constantly innovate our products we may change the quoted spec and any other details that have been documented in this manual so you should always refer to the supplier to see if the manual that was shipped with your product is the latest edition.
- As with all electrical installations you should use a qualified electrician and obey all of the latest laws and regulations.
- Be sure to fill out and complete **ALL** paperwork where instructed as this manual is the equipments log book and maintenance manual.

The "Warnings" leaflet and "Instruction booklet" supplied with this product should be read carefully as they provide important information about safety, installation, use and maintenance.

Scrap packing materials (plastic, cardboard, polystyrene etc) according to the provisions set out by current standards. Keep nylon or polystyrene bags out of children's reach.

Keep the instructions together with the technical brochure for future reference.

This product was exclusively designed and manufactured for the use specified in the present documentation. Any other use not specified in this documentation could damage the product and be dangerous.

The Company declines all responsibility for any consequences resulting from improper use of the product, or use which is different from that expected and specified in the present documentation.

Do not install the product in explosive atmosphere.

The construction components of this product must comply with the following European Directives: 89/336/CEE, 73/23/EEC, 98/37/EEC and subsequent amendments. As for all non-EEC countries, the abovementioned standards as well as the current national standards should be respected in order to achieve a good safety level.

The Company declines all responsibility for any consequences resulting from failure to observe Good Technical Practice when constructing closing structures (door, gates etc.), as well as from any deformation which might occur during use.

The installation must comply with the provisions set out by the following European Directives: 89/336/CEE, 73/23/EEC, 98/37/EEC and subsequent amendments.

Disconnect the electrical power supply before carrying out any work on the installation. Also disconnect any buffer batteries, if fitted.

Fit an omnipolar or magnetothermal switch on the mains power supply, having a contact opening distance equal to or greater than 3mm.

Check that a differential switch with a 0.03A threshold is fitted just before the power supply mains.

Check that earthing is carried out correctly: connect all metal parts for closure (doors, gates etc.) and all system components provided with an earth terminal.

Fit all the safety devices (photocells, electric edges etc.) which are needed to protect the area from any danger caused by squashing, conveying and shearing, according to and in compliance with the applicable directives and technical standards.

This article describes how your equipment will be delivered to you, specifications on the transportation used and advice including health & safety on movement of the equipment.

The turnstile should ALWAYS! be moved with care and attention. The products are very heavy individually as well as a whole. You should not attempt to move this or any other products by unapproved handling methods.

1. Incorrect

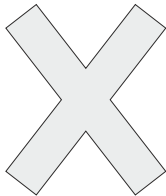

2. Correct

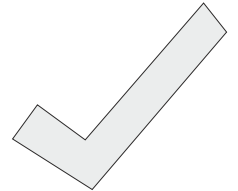
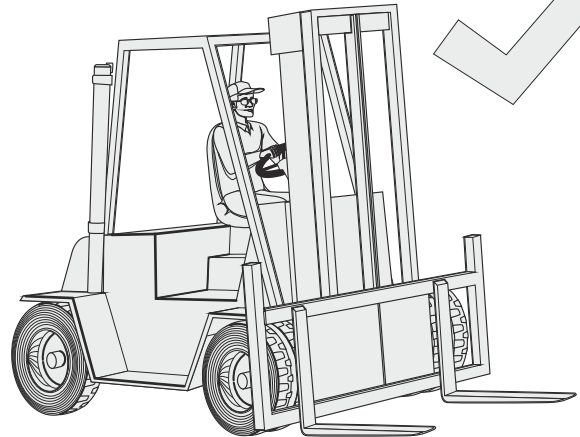

The manufacturer will use a qualified transport company to deliver the product conforming to the necessary regulations as detailed below:

- All drivers are qualified
- All drivers are tested once yearly
- All drivers carry risk assessments and method statements (available on request)
- They are controlled under law to conform as there are no trade regulation standards to comply with



Health and safety Considerations:

Moving Goods Safely (MGS) is a national project involving both the Health and Safety Executive (HSE) and Local Authorities (LA) working in partnership. The project aims to reduce injuries and ill-health arising from the movement of goods from supplier through haulier to the recipient and end user including any home deliveries. The project will focus upon the delivery and collection of goods and the hazards this generates. It covers the main areas that cause the majority of injuries and ill-health to workers, including:

- Workplace transport;
- Slips & trips, and;
- Musculoskeletal disorders (MSD).

The movement of goods presents us, as health and safety regulators, with the challenge of dealing with a huge variety of issues. The commercial organisations involved within the movement of goods are diverse including haulier, third party logistics providers, pallet networks, retailers etc, with some very large companies, thousands of small businesses and the self-employed. The movement of goods is more than just trucks on the road with a large proportion of accidents happening at the delivery/collection sites that are often not directly under the control of the company making the delivery or collection. Communication and cooperation problems can arise due to the many organizations involved in the movement of the goods, and this can also lead to difficulties in effectively managing health and safety.

(Source H&S Executive UK 2008)

## Component Identification and Notes:

You should check that you have received the following in your order as they are referred to throughout this manual (note this can change per turnstile spec i.e. single components are different from double):

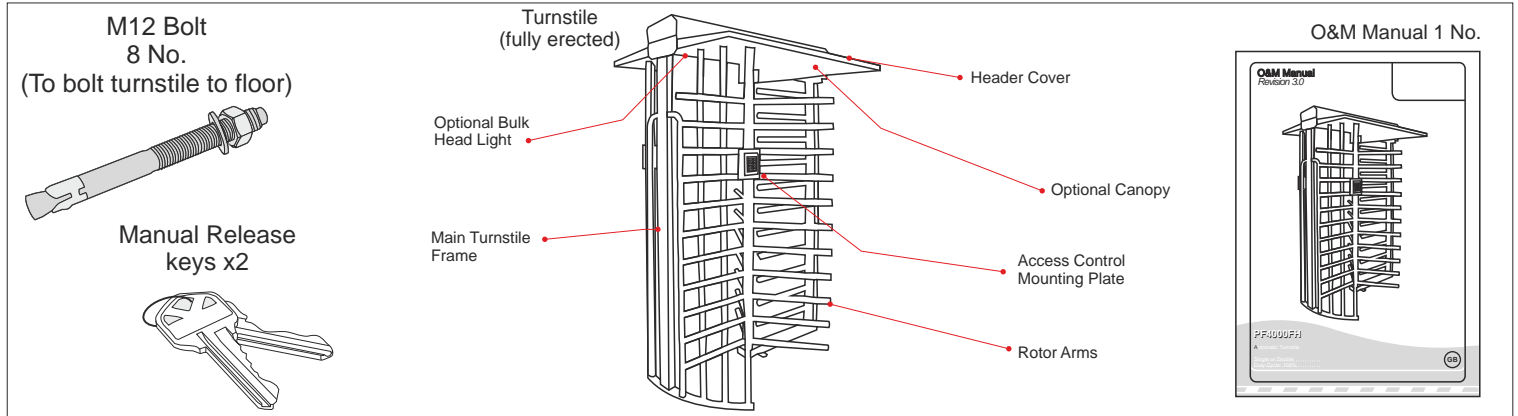

## The numbers in the text document below relate to the drawings below.

- When delivered, the turnstile will either be flat packed on a pallet or shrink wrapped and free standing, if flat packed you must assemble the turnstile making sure that everything is aligned. Check for any physical damage or defects before you sign!
- Taking into consideration that the plinth has been prepared correctly and is absolutely level and true**, Lower the turnstile onto the plinth and visually align. **Make sure that you have pulled all cables through the ducting before bolting down and that the duct is in the centre of the cable channel in the frame!**
- Using one M12 fixing, bolt down through one of the holes, it is advisable to blow the excess dust out of the hole before inserting the bolt.
- Now make sure that the turnstile is now aligned perfectly, continue to bolt down through the other holes using the remaining M12 bolts see below.  
Now move on to step 5

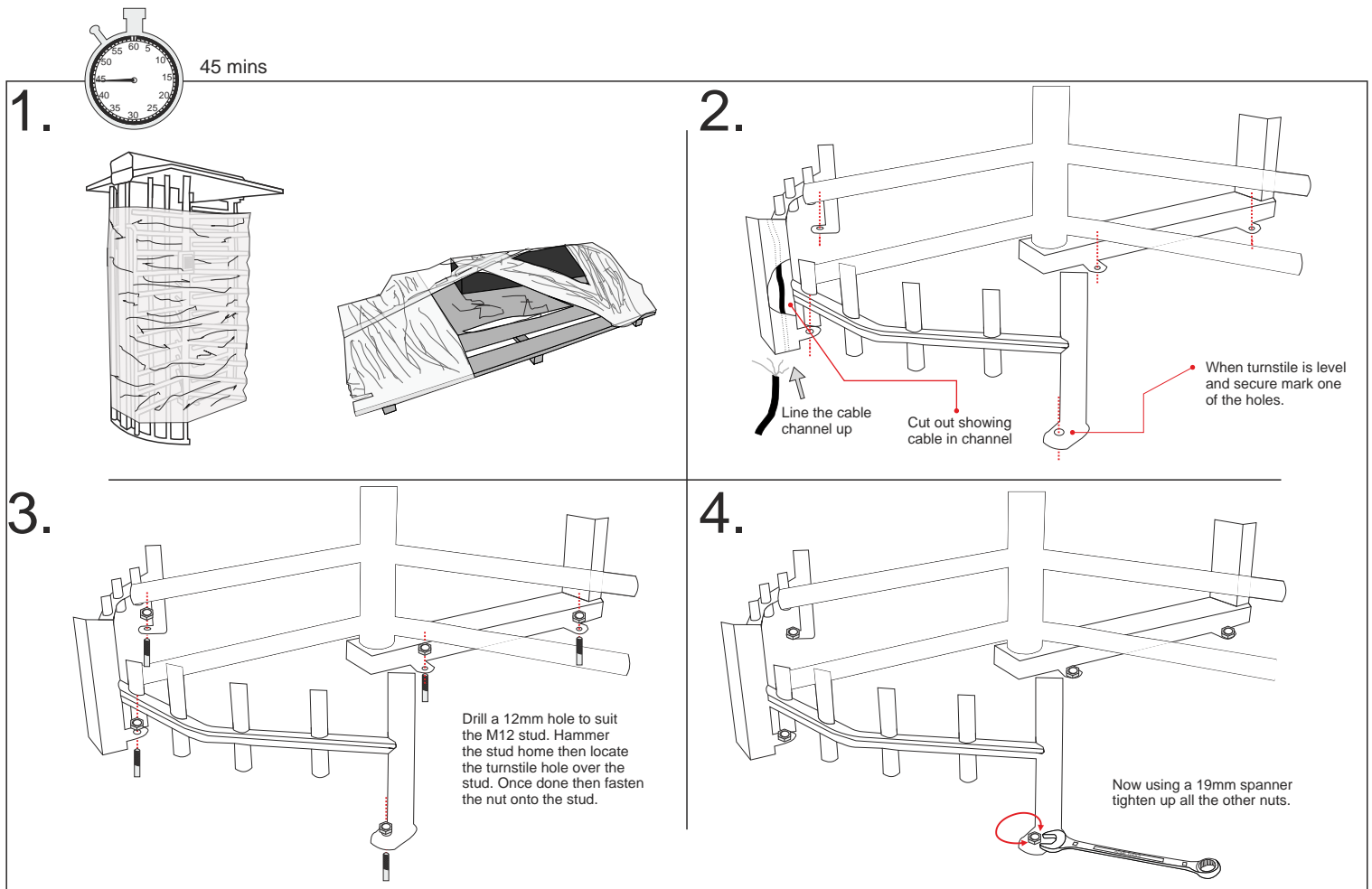

45 mins

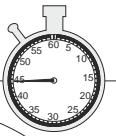

5/6.

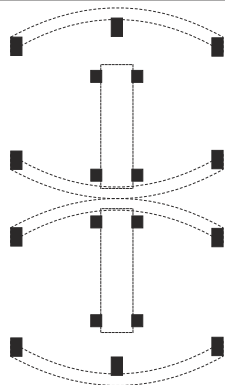
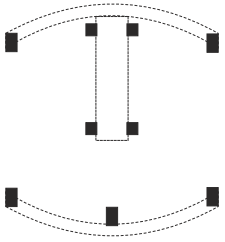

Black boxes show fixing points from a "birds eye view"

7/8.

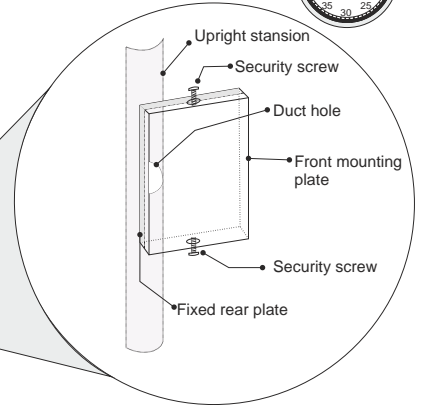
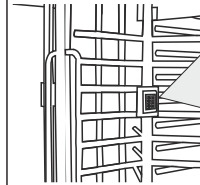

9.

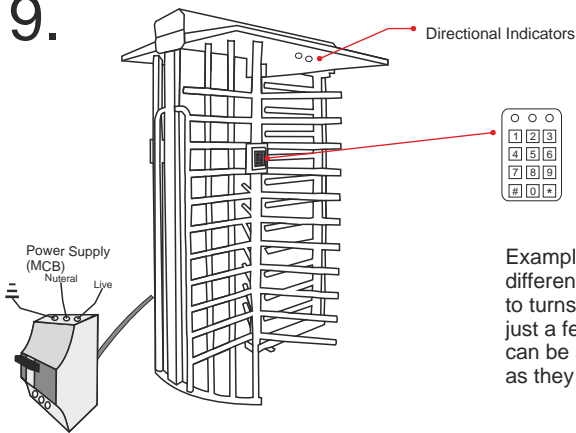

Example showing different items attached to turnstile. These are just a few of many that can be attached as long as they are volt free!

10.

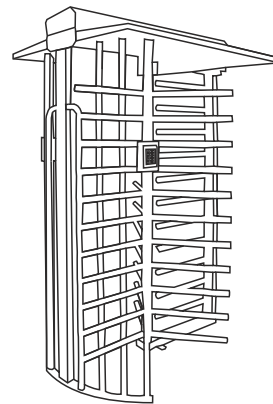

**5/6.** Shown in this illustration is the mounting holes on single turnstile (left) which has 7 mounting points. Also shown (right) is the double turnstile which has 12 mounting points. Please note that this must be installed not under duress or strain. You should make sure that the uprights are level you can use a straight building level for this.

**7/8.** This illustration shows the standard access control mounting plate. This basic illustration shows the fixing point top and bottom. Also it shows the ducting hole where you should pull your access cable through. This item is standard and if not required should be made clear at the point of order.

**9.** Now connect all power and access control using the wiring diagram on page 8. For any other specific wiring access control wiring details please contact your supplier.

**10.** Just remember to check all connections and the turnstile is earthed. Make sure the lid is closed (this is for safety reasons as the electrics will be exposed) , and make sure it is safe for the turnstile to operate.

This is a brief overview of the workings and location of parts on the header mechanism and how to set the turnstile in manual mode:

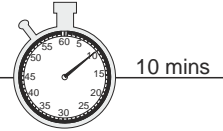

1.

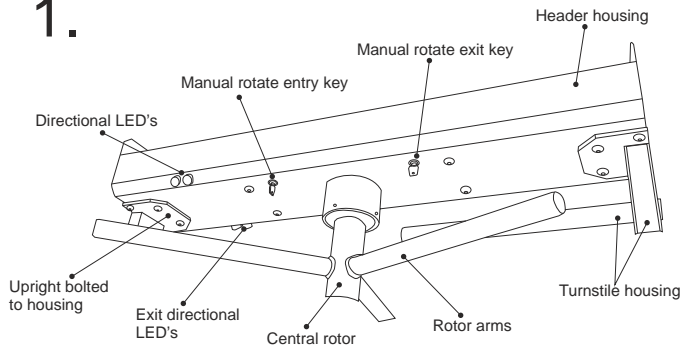

2.

3.

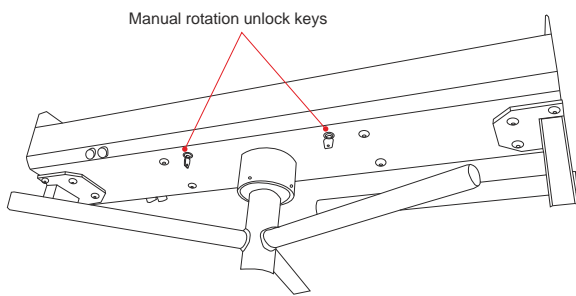

Note: the keys may not be inserted as shown into the diagram above. The keys will be strapped to the turnstile frame when sent out for delivery.

4.

20x Zoom Showing Key Operation

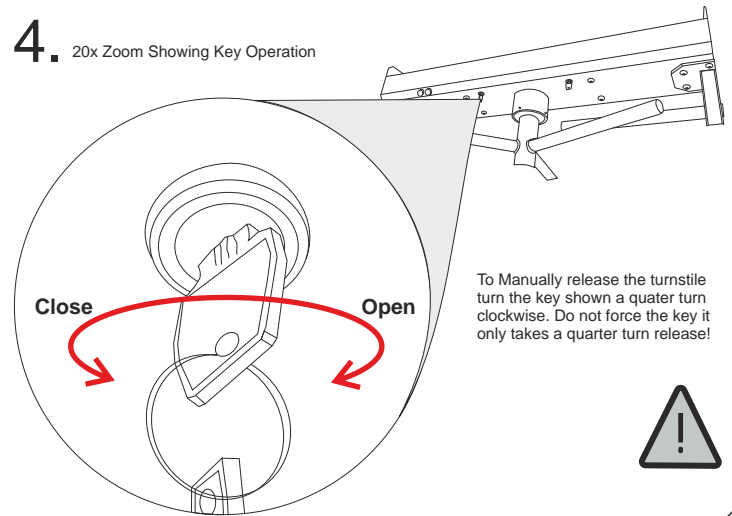

To Manually release the turnstile turn the key shown a quarter turn clockwise. Do not force the key it only takes a quarter turn release!

## Turnstile Maintenance

## PF4000FH

As stated at the beginning of this manual we recommend a bi-annual service, but at a bare minimum, it is imperative that you get a service done once every 12 months. This is not a sales tactic in disguise, there is a very serious health and safety issue/risk associated with not complying to this. Also in order for your equipment to keep complying with the appropriate legislation.

Before carrying out any maintenance to the installation, disconnect the mains power supply.

1. All moving mechanical header parts should be greased once every 6 months
2. Rotor arm rotation checked and secured.
3. All ground fixing nuts to be checked for corrosion.
4. All ground fixing nuts should be checked for tightness and secure the turnstile two the ground.
5. All electrical connections should be checked in accordance with the latest safety standards.
6. All welds and interconnecting parts should be checked for tightness and security.
7. Any defects or failure in the coating of the turnstile should be noted and reported immediately to the seller or manufacturing company.
8. Rotor arms should be checked for correct function and angle these should be corrected as needed.
9. The turnstile should be checked for any abnormalities that may cause harm or defect to an object or person.
10. The turnstile control board wiring and general condition should be checked.
11. The turnstile header mechanism should be checked for general condition and mechanical functions to ensure correct operation.
12. All solenoid's and limit switches should be checked for correct operation.

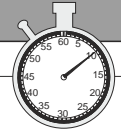

10 mins

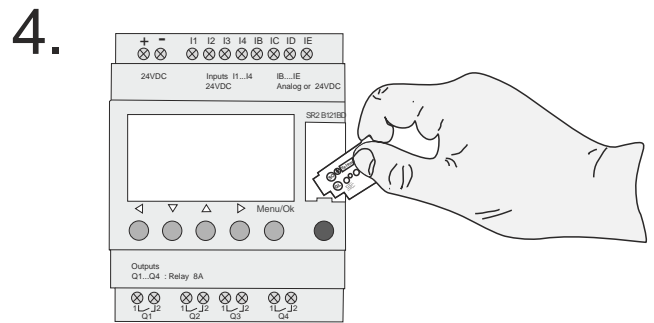
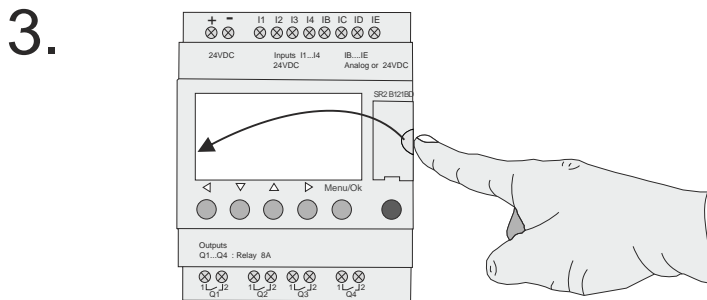
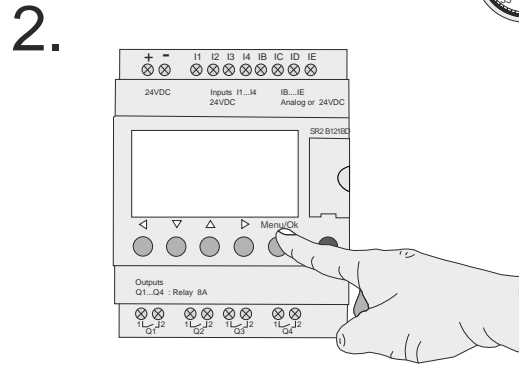
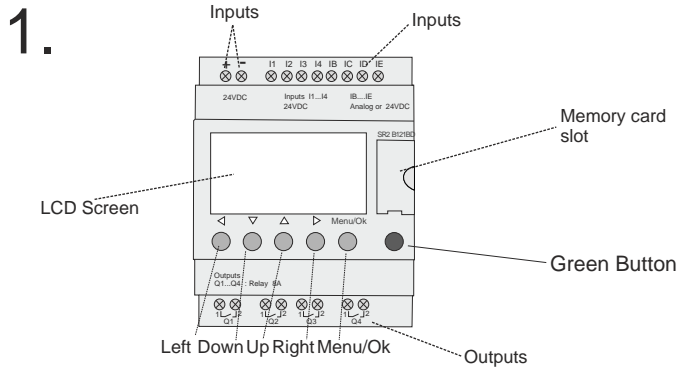

1. Shows where key components are located on the Programmable Logic Control.
2. To program the PLC using the instructions below the only tool you need to use is one finger making sure to press the correct buttons in the correct sequence.
3. To upload a new program via a PLC memory chip open the memory card slot flap and move to step 4.
4. Now follow the instructions below very carefully. When asked to insert the chip, hold the chip so that the memory word is the correct way up and at the top. Then with even force push forward into the slot so its sits flush to the PLC housing. Once inserted leave it in place until it states "download complete". After all steps have been completed you MUST replace the slot cover.

*Steps to upload a new program from Eeprom:*

1. Press menu / ok button once.(Green Button)
2. Scroll down to run / stop (flashing).
3. Insert New PLC chip
4. Press menu / ok button to stop program.(Green Button)
5. Press menu / ok again.(Green Button)
6. Scroll down to transfer (flashing).
7. Press menu / ok button once.(Green Button)
8. The screen will display transfer:  
Zelio > memory  
Memory > Zelio
9. Scroll down to **Memory > Zelio. NOTE! this is very important to select the right path as you may risk wiping the memory!!**▲
10. Press menu / ok button.(Green Button)
11. When downloaded TRANSFER OK / STOP LD will be displayed.
12. Press menu / ok button.(Green Button)
13. Scroll up to run / stop (flashing).
14. Press menu / ok button.(Green Button)
15. Screen will display RUN PROG.  
YES (with nonvolat) (flashing)  
NO
16. Make sure "YES" is selected then press menu / ok button.(Green Button)
17. The chip has now been downloaded.
18. STOP CIRCUIT BROKEN may now appear on the screen because the cabinet door is open.
19. Now replace the memory slot cover!.

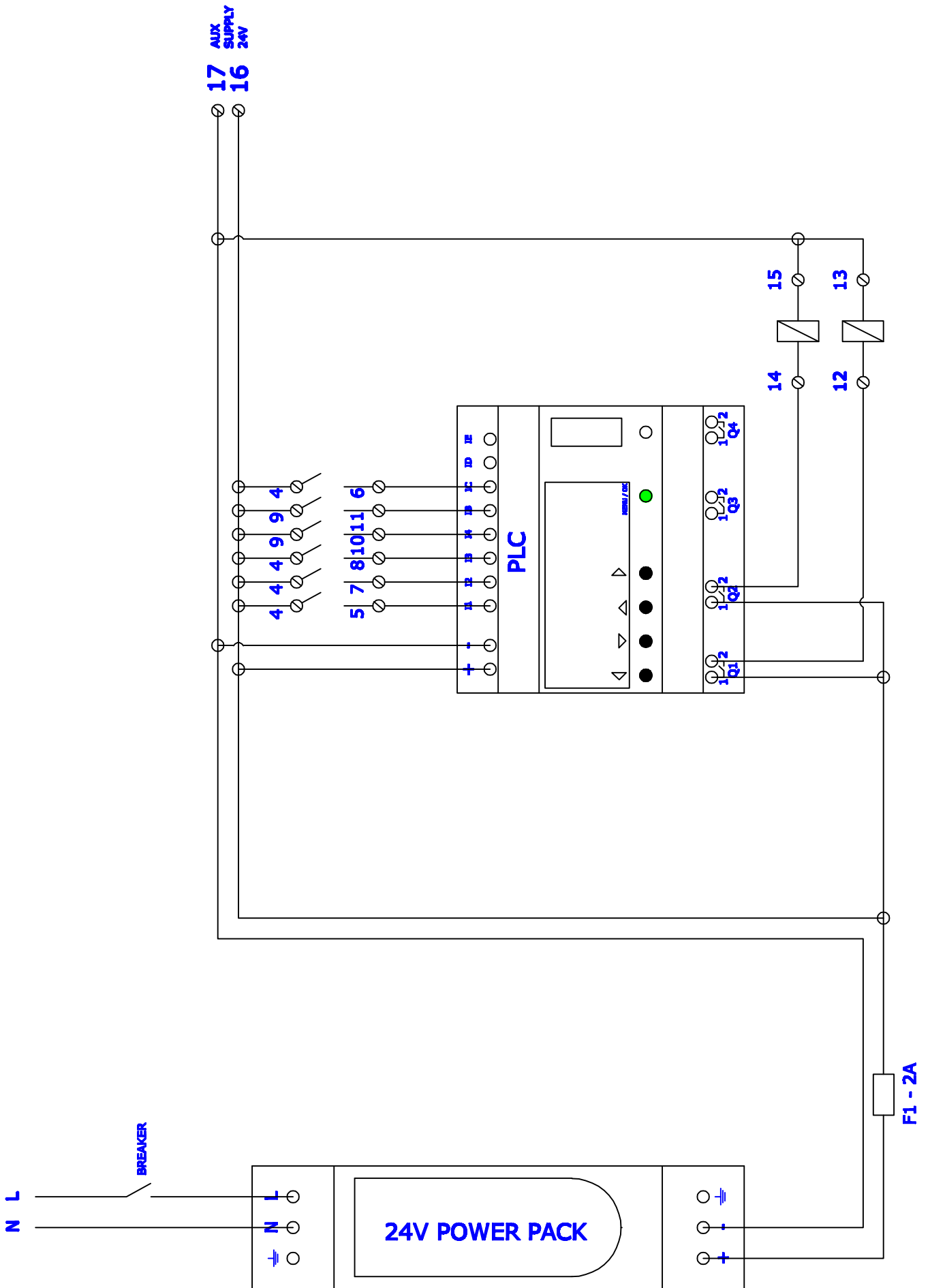



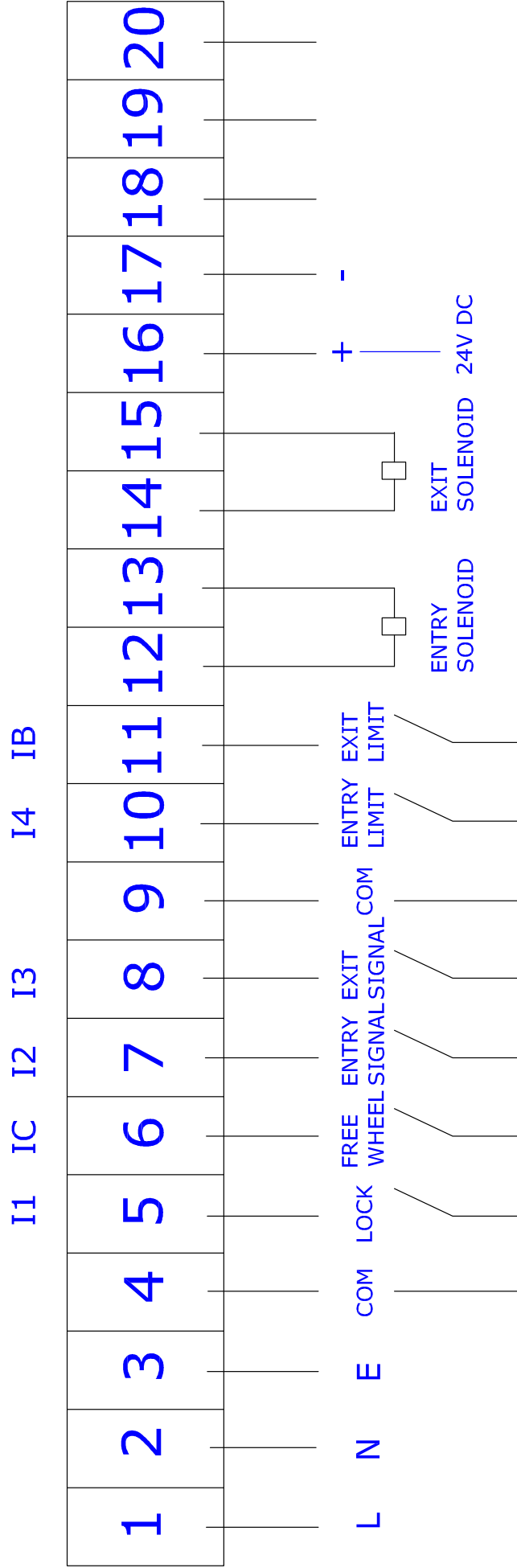

PLC and Electrical Guide

Overview picture of Internal Wiring

(Note items/locations can vary depending on model/spec)

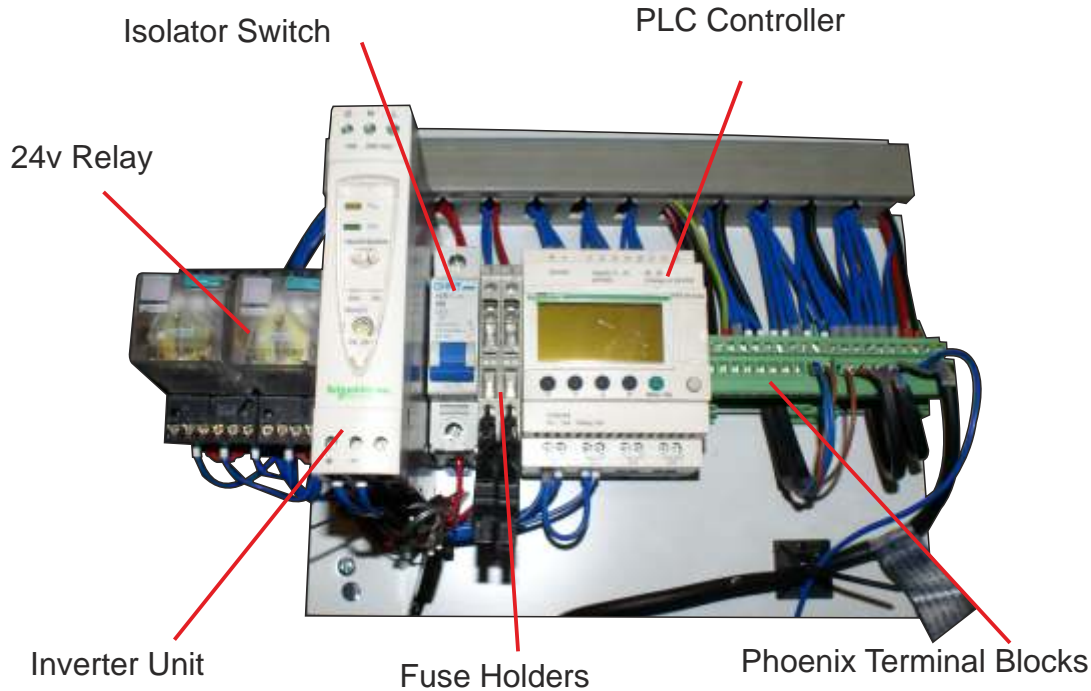

Detailed Internal Wiring **PLC Inputs/Outputs**

(Note items/locations can vary depending on model/spec)

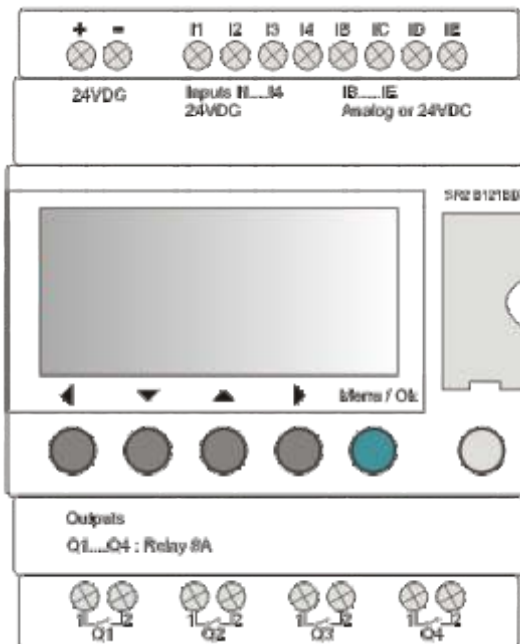

+	POSITIVE 24VDC INPUT
-	NEGATIVE 24VDC INPUT
I1	LOCK
I2	ENTRY SIGNAL
I3	EXIT SIGNAL
I4	ENTRY LIMIT
IB	EXIT LIMIT
IC	FREEWHEEL
ID	SPARE INPUT
IE	SPARE INPUT
Q1#1	24V COMMON
Q1#2	ENTRY SOLENOID
Q2#1	24V COMMON
Q2#2	EXIT SOLENOID
Q3#1	SPARE OUTPUT
Q3#2	SPAREOUTPUT
Q4#1	SPARE OUTPUT
Q4#2	SPARE OUTPUT

**WARNING:** THE POWER SUPPLY FOR THE DEVICES OPERATING THROUGH EXTERNAL SOURCES MUST NOT BE RECEIVED FROM THE PLC INSIDE THE TURNSTILE

Mechanical Header Guide

Overview picture Turnstile Header



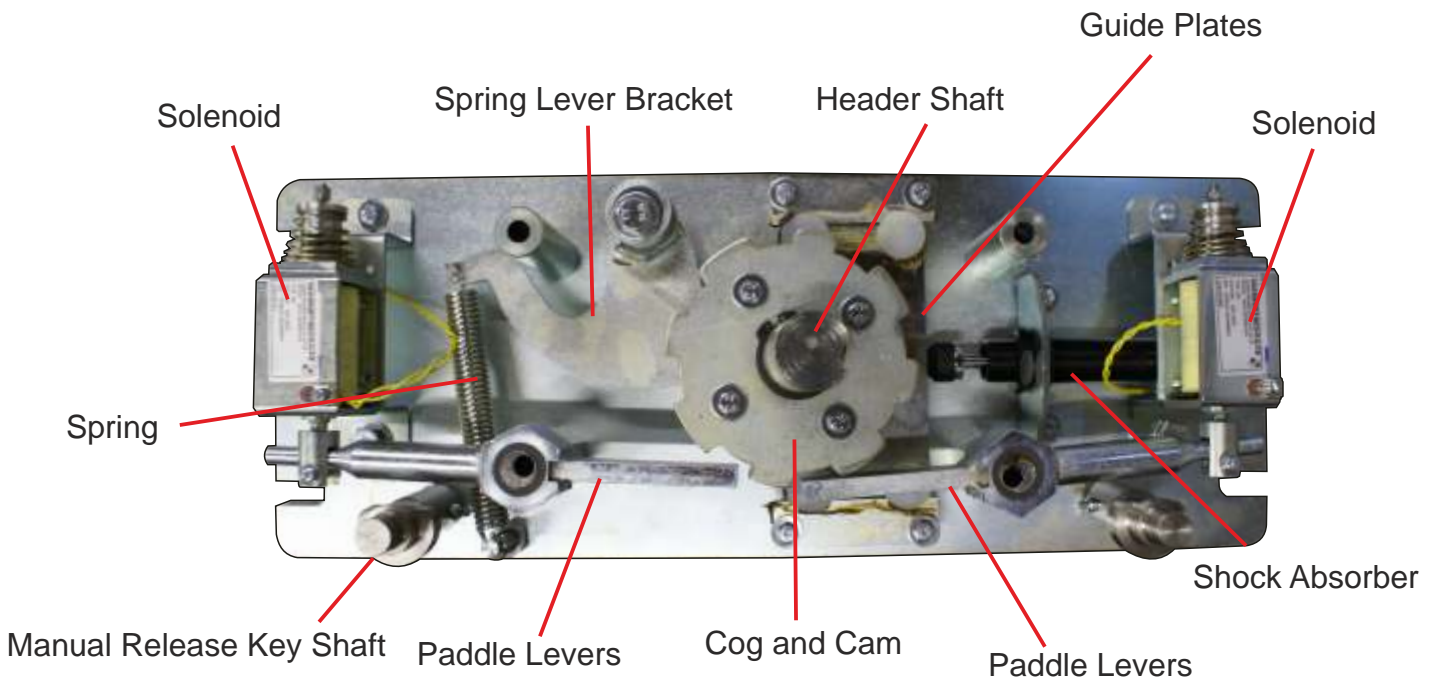
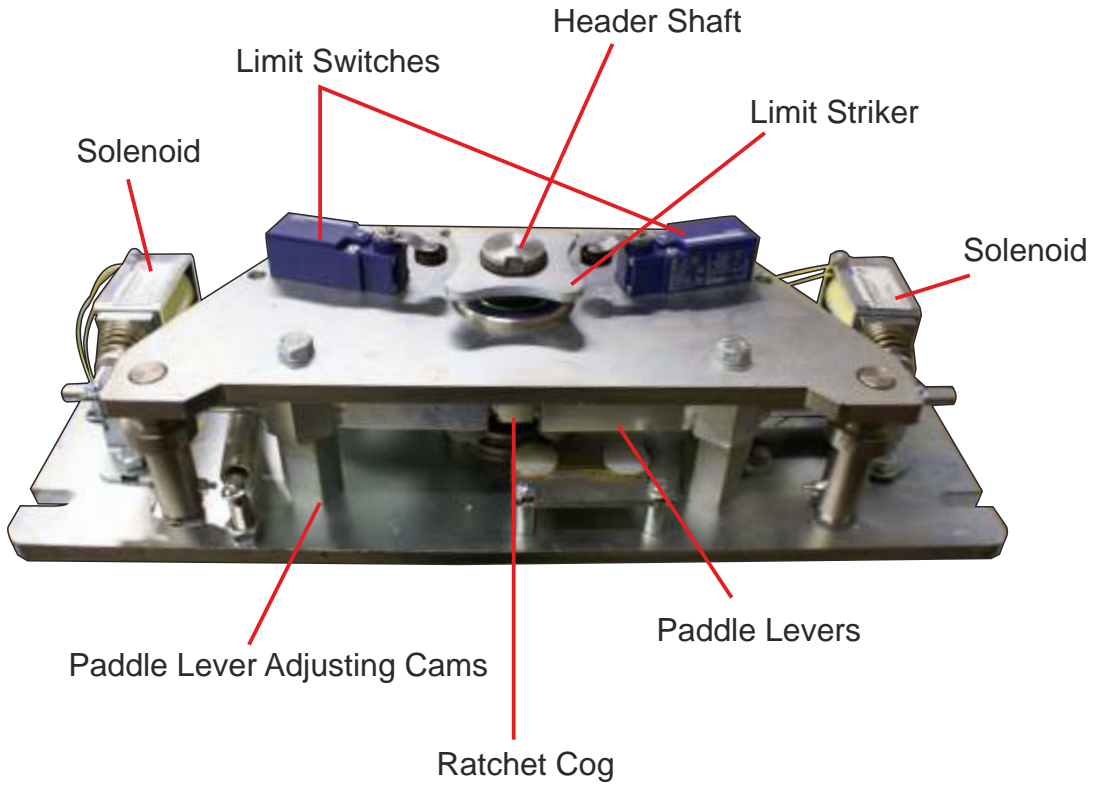

(Note items/locations can vary depending on model/spec)

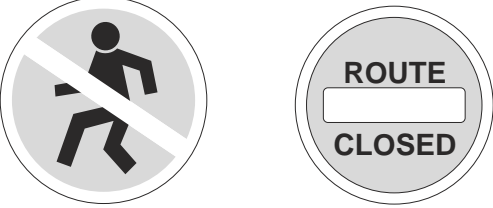

## First Operation Manoeuvres

1. Before attempting the steps outlined below please obey common sense and be aware that the turnstile will inhibit movement until commissioned so provide a diversion and inform site inc pedestrians.
2. Follow the manual release guide in this manual and make sure the turnstile moves un-hindered by inserting the key and checking rotation in both directions.
3. If the above step is ok then proceed to close the Turnstile using the manual method and then power on using the isolator switch as shown (if fitted).
4. Now the cabinet door must be closed for the Turnstile to work automatically.

<p>1.</p> 	<p>2.</p> 
<p>3.</p> <p>An isolator is fitted to activate push forward to power on the turnstile.</p>	<p>4.</p>

There are many options to operate the Turnstile as it is dependant upon which type of access control you have connected. However there is a standard way to operate the Turnstile by using the key switch and the PLC . Instructions are assisted by pictures below.

1. Picture shown below is the key switch which is located on the outside of the Turnstile cabinet (it will always be on the opposite side to the Turnstile arm, also picture shows the key switch keys.
  2. To move the Turnstile arm using the PLC first make sure the screen says "RUN LD" if it does not follow the troubleshooting guide on page 11 when the screen says "RUN LD" follow below.
  3. To make the Turnstile move upwards or to "open" press the up arrow.
  4. To make the Turnstile move down or to "close" press the down arrow.
- Please note that the above 2 manoeuvres will not work if there is something in the way of photocells or on the loops.

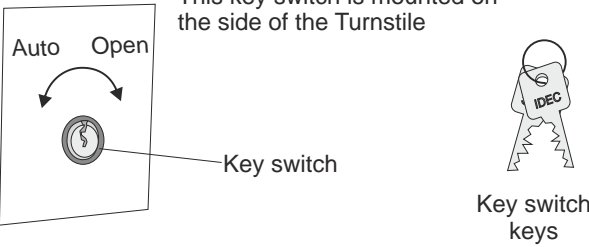
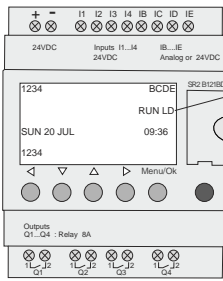
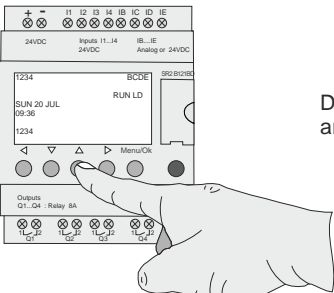
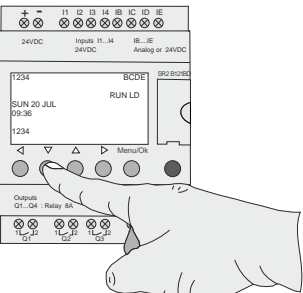
<p>1.</p>  <p>This key switch is mounted on the side of the Turnstile</p> <p>Auto Open</p> <p>Key switch</p> <p>Key switch keys</p>	<p>2.</p>  <p>Display showing run mode</p>
<p>3.</p>  <p>Drawing showing the "UP" arrow being pressed</p>	<p>4.</p>  <p>Drawing showing the "DOWN" arrow being pressed</p>

The table (bottom) relates to the diagram directly below to help you trouble shoot electrical component errors

**1.**  
Example showing number I1 and IB input selected

Showing program in "run mode"

Input displays which change as inputs used as detailed in the table below.

Date/Time Display

**2.**  
Example showing number Q1 and Q3 output selected

Showing program in "Stop mode"

Output displays which change as Outputs used as detailed in the table below.

Date/Time Display

1. Inputs			
Input	Polarity	Connected to	Operation when active
I1	Normally Closed	Lock	Turnstile stops if door open
I2	Normally Open	Entry Signal	Raises Turnstile
I3	Normally Open	Exit Signal	Lowers Turnstile
I4	Normally Open	Entry Limit	Detects Vehicle on loop then lowers if no detection present
IB	Normally Open	Exit Limit	Detects vehicle on loop/Lowers when not detected
IC	Normally Open	Freewheel	Turnstile opens when vehicle present on loop
ID	Normally Open	Spare Input	Arm has reached fully closed position
IE	Normally Open	Not Used	Spare not used
2. Outputs			
Output:	Polarity:	Connected to:	Operation when active:
Q1	Normally Open	Q1(1) = 24v Common Q1(2) = Entry Solenoid	Active to open Turnstile
Q2	Normally Open	Q2(1) = 24v Common Q2(2) = Exit Solenoid	Active to close Turnstile
Q3	Normally Open	Spare	Spare Not Used
Q4	Normally Open	Spare	Spare Not Used

**Note:**

For custom programs or "bespoke" solutions please contact us. Do not attempt to modify or change the program without prior consent as this may pose a health & safety risk. Always use a qualified technician to make any major changes to the generic control program.

WHAT IS THE PROBLEM?	WHAT CAN BE THE REASON?	WHAT CAN BE DONE?
Turnstile allows authorisation to passage into one direction continuously.	1-It may be set out into "single way free" mode. 2-Locking solenoid cable may be displaced or broken down. 3-Spring of locking hook spring may be displaced or broken off.	1-It is re-arranged from DIP-switcher into standard operating mode. 2-Cable is being checked out and replaced if broken down. 3-Spring is fixed into place or replaced with a new one.
For the turnstiles equipped with a dropping arm unit, arm is not dropping in case of emergency.	1-The arm dropping batteries of turnstile may be discharged. 2-Battery cables may be displaced. 3-The cable of arm dropping solenoid may be displaced. 4-Arm shaft pin of dropping arm mechanism may be tightened.	1-Batteries are charged or replaced with new batteries, charging circuit is being checked out. 2-Cables are plugged again. 3-Cables are plugged again. 4-Arm shaft pin is being fixed or replaced with a new one.
*When the arm is placed into original position after dropping, it drops again without being activated and does not stay in its place fixed.	1-Dropping arm shaft pin may be tightened.	1-Arm shaft pin is being fixed or replaced with a new one.
When power is being supplied, arms are not locked; red light is being seen on the indicators.	1-Cable of direction sensor may be broken off or photocell units are become dirty with dust. 2-Cable of direction sensor may be displaced from connector on the electronic card. 3-One of the direction sensors may be broken down.	1-Broken cables, if any, are soldered. The unit is cleaned from the dust. 2- Cable of direction sensor is plugged again to the connector. 3-The direction sensor is replaced.
Turnstile is not being reset at the end of specified time after turnstile allows authorisation for passage. After the finalisation of the passage, no feed back is being received regarding with passing direction.	1-Dip-switch control may be turned off. 2-Connection ends of the data connector may not be fixed correctly or may be broken down. 3-Electronic card may be broken down.	1-DIP switch position is being set to its standard place. 2-Connections are checked out. 3-Electronic card is replaced with a new one.
After passage is done, arms do not finalise the movement and do not settle to their place.	1-Springs of balance arm may be displaced or broken off. 2-Copper of braking magnet may be worn out. 3-Braking magnet tuning may be disordered. 4-Hydraulic damper tuning may be disordered.	1-Springs of the balance arm are fixed into their place or replaced with new ones. place. 2-Copper of the braking magnet is replaced with the new one. 3-The space between braking magnet and braking magnet plate is being increased by pressing the plate layers to ensure the weakening of the the magnet. 4-Tuning is being made again.
After the passage, turnstile arms are not locked and make a rotation or turn more than technically specified.	1-Spring of locking hook may be broken down. 2-Solenoid of locking hook may not be working properly. 3-The core of locking hook solenoid may be enlarged.	1-2-Spring of locking hook is replaced with the new one. 3-If the core of locking hook solenoid is enlarged, core is replaced with the new one.



The best way to approach any error is to take time, be thorough and systematic in fault finding.



Before moving any wires ensure all power is disconnected to avoid shock.

WHAT IS THE PROBLEM?

WHAT CAN BE THE REASON?

WHAT CAN BE DONE?

Although the power is supplied, arms are not locked, indicators do not light, no operation is monitored in the turnstile.	1-Power might not be received. 2-Internal power cable might be displaced. 3-3 amper glass fuse might be broken down.	1-Power is supplied to the turnstile. 2-Power cable is checked out whether it is plugged or not. 3-3 amper glass fuse is changed.
There is energy but arms are rotating idle.	1-Locking magnet cables or cables of photo-cell unit (position informing) might be displaced. 2-Electronic board might be broken down.	1-If there is a displaced cable, it is plugged again. 2-If the electronic board is broken down, it is replaced with a new one.
Although there is pass signal (pass indicator, buzzer) turnstile does not allow authorisation for passage.	1-There might be a foreign object which prevents the operations of the solenoids of the locking hook (like a cable). 2-There might be a failure in the microcontroller on electronic board or ULN 2803 A circuit that drives the solenoids.	1-Objects which prevent operations are moved from the area. 2-Microcontroller and ULN 2803A circuit or electronic board is replaced with a new one.
There is no pass signal (pass indicator, buzzer) but the turnstile allows authorisation for passage.	1-Pass indicator cable might be displaced. 2-Microcontroller on the electronic board or ULN 2803 A circuit that drives the pass indicator may be broken down.	1-If there is a displaced cable, it is plugged again. 2-Microcontroller and ULN 2803A circuit or electronic board is replaced with a new one.
After passage is done, arms do not finalise the movement and do not settle to their place.	1-Balance arm spring might be displaced or broke off. 2-Hydraulic damper tuning might be changed.	1-Balance arm spring is replaced by a new one or plugged again. 2-Hydraulic damper tuning is set to the specified level by means of tuning capscrews.
After the passage, turnstile is not being locked and arms rotate continuously.	1-Spring of locking hook might be broken off or displaced. 2-Photocell unit might be broken down. 3-Electronic board might be broken down.	1-Locking hook is replaced with a new one. 2-Photocell unit is replaced with a new one. 3-Electronic board is replaced with a new one.
During passage, sometimes arms do not rotate smoothly.	1-Spring of return locking pin might be broken off that releases the pin.	1-Spring of return locking pin is replaced with a new one.
Turnstile does not allow passage although pass signal is being received.	1-15' data connector may be displaced or not being connected correctly. 2-Commands may not be received. 3-Electronic card may be broken down. 4-The problem may be related with the solenoid.	1-2-The connections are checked out to see whether the commands are being received or not. 3-Electronic card is replaced with a new one. 4-If a malfunctioning is being recognised at the solenoid, it is replaced with a new one.
After the finalisation of the passage, "return" data regarding with the passage direction is not seen.	1-Connection ends of the data connector may not be fixed correctly or may be broken down. 2-Electronic card may be broken down.	1-Connections are checked out. 2-Electronic card is replaced with a new one.

We certify that the system covered by this certificate has been commissioned satisfactorily.

Contract Reference		Completion	
Contract Title		Engineers Installing	
Installation Commenced	/ /20	Commissioning	
Works Description			
Part/Whole Certificate			
Handover Date			

Part 3. The system(s) designed and installed in accordance with the following documents:

<u>Document Ref:</u>	<u>Revision</u>	<u>Description</u>
Pf4000 O&M	3.0	System guides and drawings as defined within O&M Manuals

Part 4. The following test schedules refer:

Test Schedules /Commissioning Certificate

Part 5. Existing Installation Items not covered under warranty/ This certificate:

Part 6. Certificate Signing off Section

Installers Name		Signature	
On Behalf of		Date of Signing	
Address		Position	
		Parts Handed Over	Qty:
Client Name		Signature	
On Behalf of		Date of Signing	
Address		Position	
		Parts Handed over	Qty:

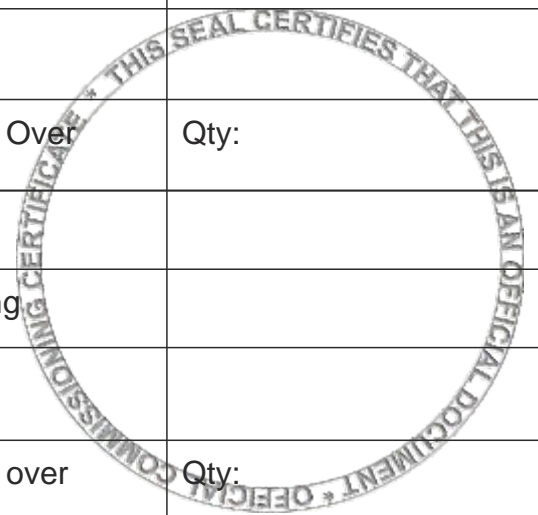



System Operation - The user FULLY understands	YES	NO
How to operate the system with all control devices	<input type="checkbox"/>	<input type="checkbox"/>
How to isolate the power to the automation system	<input type="checkbox"/>	<input type="checkbox"/>
How to manually release the system in event of power failure	<input type="checkbox"/>	<input type="checkbox"/>
The safety rules and issues associated with your system	<input type="checkbox"/>	<input type="checkbox"/>
Safety devices on the system have been verified and checked	<input type="checkbox"/>	<input type="checkbox"/>
Safety devices and features suit the site/application for which it was designed	<input type="checkbox"/>	<input type="checkbox"/>
How to open the door on the equipment	<input type="checkbox"/>	<input type="checkbox"/>
Check the following items	YES	NO
Door keys have been handed over	<input type="checkbox"/>	<input type="checkbox"/>
Key switch keys have been handed over	<input type="checkbox"/>	<input type="checkbox"/>
All equipment and site has been left in a clean and safe state	<input type="checkbox"/>	<input type="checkbox"/>
Any warning signage has been fitted by Engineer/Client to make people aware	<input type="checkbox"/>	<input type="checkbox"/>
Any times and special programming instructions undertaken	<input type="checkbox"/>	<input type="checkbox"/>
Product works the way site need it to this includes "no passage time out" etc	<input type="checkbox"/>	<input type="checkbox"/>
System has had the completed conformity certificate	<input type="checkbox"/>	<input type="checkbox"/>
All items on the delivery note have been handed over to client/site - <small>this should be signed for on the separate sheet which is titled "Delivery Note" (green/ or yellow paper) if parts missing call supplier</small>	<input type="checkbox"/>	<input type="checkbox"/>
The engineer has expressed the importance of regularly maintaining the equipment	<input type="checkbox"/>	<input type="checkbox"/>
POWER ISOLATION - The power isolator for your automation system is located at: .....		

The following denotes that the above has been completed to a satisfactory standard. The engineer has explained the system of operation to you and any devices that you have had fitted. If this is agreed and has been displayed please sign in the indicated fields below. All information will be passed on correctly to other system users. The users of the system will use this system correctly and safely.

Engineers Name: ..... Engineers Signature: .....

Clients Name: ..... Clients Signature: .....



This Manual **must** be completed in accordance with the guidelines below, **at any point** service/repair work is carried out on the product. This is to achieve two things;

1. To keep a history of the product for yourself and your supplier/manufacturer.
2. To keep an accurate log of any historical or recent modifications, and/or problems, to help an engineer in the event of any future work required on the product.
3. This page is continued on the next page if extra space is needed.

Date	Reason for visit/Action taken	Engineers Signature
/ /20		
/ /20		
/ /20		
/ /20		
/ /20		
/ /20		
/ /20		
/ /20		
/ /20		
/ /20		
/ /20		
/ /20		
/ /20		
/ /20		
/ /20		
/ /20		
/ /20		
/ /20		
/ /20		

The machinery which this declaration refers to, is in accordance with the conditions of the following directives;

Machinery Directive 98/37/CE.  
Low Voltage Directive 73/23/CEE.  
Electromagnetic Compatibility Directive 89/336/CEE.

And is in conformity with the following standards & other specifications;

EN292-1 1991 Machinery basis terminology & methodology.  
EN292-2 machinery technical principles & specification.  
EN6100-6-3 Electromagnetic compatibility – Immunity generic standard residential, commercial and Heavy Industry.

Made in the UK  
Name: Anthony Green  
Position: Managing Director



Digitally Protected

### Dimensions:

Single: 1480mm x 1410mm x 2350mm  
 Double: 2220mm x 1500mm x 2350mm  
 Rotor: 76mm Ø tube with bottom support bearing  
 Arms: 42mm Ø tube with capped ends  
 Side frames: 33mm Ø tube welded to curve base plate

### Rotor Spec:

Type: Worm & Wheel  
 Overall speed: 9 rpm  
 Max rated torque: 440nm  
 Actual torque: 320nm  
 Gearbox efficiency: 55%  
 Output size: 35mm  
 Mounting position: V5  
 Angular Backlash: 15' +/- 5' / 0.00436 +/- 0.00145  
 Lubricated with: Shell Tivela S320  
 0.90 litres

## PF4000FH

### Specification

**Power Requirement:** 220v, Single Phase, 50Hz, 5 Amps

**Arms and body:** Primed/Powder Coated finish

**Duty Cycle:** 100% continuous duty rating

**Flow Rate:** 15 to 22/min in a single direction

**Key Points:** Bi-Directional control Fail safe or Fail secure, Factory settings need no adjustment, PLC controlled can work with all access and revenue systems, cable routes through side frames, Turnstiles will suit interior and exterior installations.

**Access Controls:** Push-button, Proximity cards, card readers, tokens, voice/video intercoms, keypads and remote fobs.

## Accessories

### Optional extras:

- Directional Flow indicator lights
- Canopy
- Siren/Sounder
- Bespoke Signage

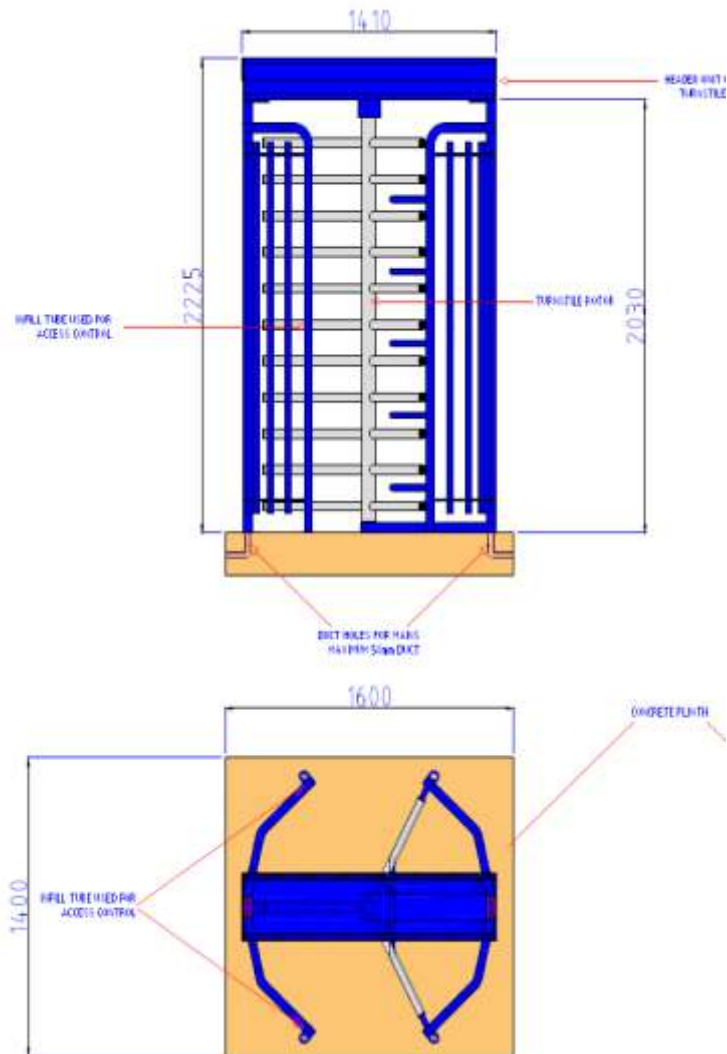

**CE** EUROPEAN MARK CERTIFYING CONFORMITY TO THE ESSENTIAL REQUIREMENTS OF THE STANDARDS 98/37/EC

**Proudly Made in the UK**

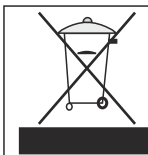

**GB** 2003/108/CE Directive for waste electrical and electronic Equipments  
**DISPOSE OF PROPERLY**  
 ENVIRONMENT - NOXIOUS MATERIALS

The manufacturer reserves the right to make amendments to this manual without prior notice and declines all responsibility for any errors, personal injury or damage to property.